

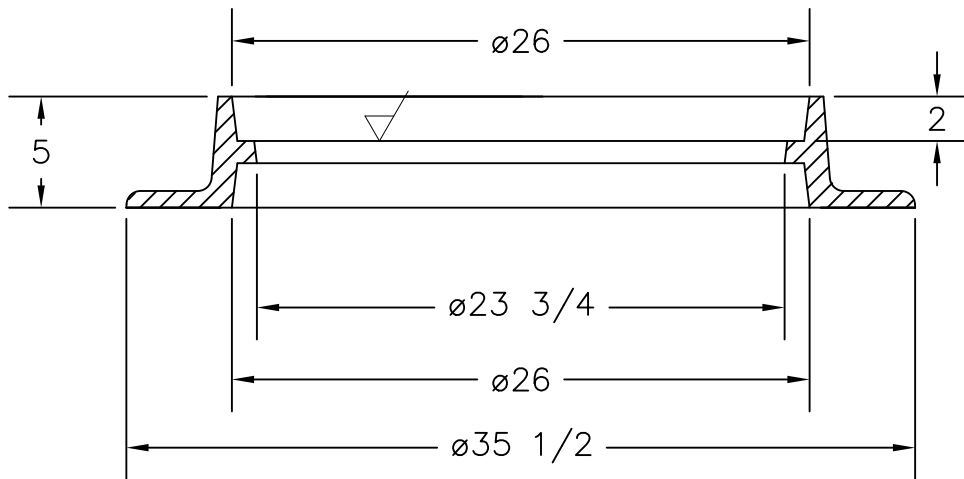

(2) NON-PENETRATING PICKHOLES



US FOUNDRY
 AN EAGLE MANUFACTURING COMPANY © 2013 All Rights Reserved

8351 NW 93rd Street
 Medley, FL, 33166-2025
 ph: 1-800-432-9709
 fax: 305-887-9429
 www.usfoundry.com

USF 726 Ring & DN Cover

LOAD CLASSIFICATION: Heavy Duty		
MATERIAL: ASTM-A48 GRAY IRON CLASS 35B		
Ring No:	8020463	SCALE:
Cover No:		DATE:
		12/13/2013
		OWN. BY:
		AB
REV: 0	DATE:	REV BY:
		QUOTE#